



PurA-Q+
Ultra-Pure Water System
with Total Organic Carbon Monitoring

Operation Manual

OP-000134

Revision A

December 2021

Scientific Laboratory Supplies Limited

Wilford Industrial Estate

Ruddington Lane • Wilford • Nottingham NG11 7EP

Tel: +44(0) 115 982 1111

E-mail: slsinfo@scientificlabs.com

© 2021 Avidity Science, LLC. All rights reserved.

Brand and product names are trademarks or registered trademarks of their respective holders.

Although Avidity Science, LLC. has taken every precaution when preparing this manual, Avidity Science, LLC assumes no responsibility for errors or omissions, nor does Avidity Science, LLC assume liability for damages to your system resulting from the use of the information in this manual.

Information in this document is subject to change without notice and does not represent a commitment on the part of Avidity Science, LLC.

Contents

Important Safety and Service Information	iii
RoHS/WEEE Statement	iii
Hazard and Special Safety Notice Definitions	iii
Product Warnings	iv
Product Caution	iv
Introduction	1
Water Quality Flow Rates	1
Purification Process	1
Feed Water Requirements	4
Product Water Specifications	4
Dispense Controller Primary Operation Menus and Sub-menus	5
Operation	7
Information Screen	7
User Settings	7
System Settings	7
Consumable Timers	8
Alarms (Warnings)	8
Change Language	9
Configure User Settings	9
Dispensing Deionized (DI) Water	10
Dispensing Type I Water	10
Warning Messages	14
Routine Maintenance	15
Replace Pre-Treatment Module	15
Replace Endure Purification Pack TC002	18
Sanitise the System	21
Sanitize the External Storage Tank (as required)	25
RO Clean	30
Replace Endotoxin Filter or Bacteria Filter	37
Replace Air Filter on External Storage Tank	38

Consumables and Replacement Parts 39

Consumables 39

Replacement Parts 39

External Storage Tank Replacement Parts 41

Important Safety and Service Information

The customer should comply with their organization's Electrical Safe Practices as recommended by the Occupational Safety and Health Administration (OSHA), or local and national safety codes.

This equipment must be used as designed and operated by qualified persons who are knowledgeable and trained in its operation, and its associated hazards.

Use caution when operating, or servicing this equipment. It is the user's responsibility to read and understand the content of this manual before operating this equipment.

SAVE THESE INSTRUCTIONS

RoHS/WEEE Statement

This equipment is manufactured in compliance with the RoHS Directive (EU Directive 2011/65/EU and subsequent amendments).

Hazard and Special Safety Notice Definitions

Below is a list of definitions of hazard symbols used on this product.



WARNING! Risk of electrocution or electrical shock resulting in death or severe personal injury.



WARNING! Could result in death or serious personal injury or equipment damage.



CAUTION! Minor or moderate injury or equipment damage

This manual may contain the following types of special notices.

IMPORTANT: Indicates information that is necessary to understanding a topic or performing a procedure.

NOTE: Indicates information that may be helpful in understanding a topic or performing a procedure.

Product Warnings



WARNING! Electrical shock. Install this equipment on a ground fault interrupting circuit. Not installing this equipment on a ground fault interrupter circuit can cause electrical shock resulting in severe personal injury or property damage.



WARNING! Electrocutation. Never stand in water when handling electrical equipment. Water is a conductor of electricity. Standing in water while operating this equipment can cause electrical shock or electrocution resulting in severe personal injury.



WARNING! Electric Shock. Disconnect the main power before servicing any electrical components. Failure to do so can cause electrical shock resulting in personal injury.

Product Caution



CAUTION! Personal injury. Use this product for its intended use only, Failure to use this product as designed by the manufacturer may result in personal injury and equipment failure.



CAUTION! Equipment damage. Follow all nationally and locally approved electrical codes when installing this equipment. Failure to do so can result in equipment damage.



Introduction

The PurA-Q+ Ultra-Pure Water System provides dual water purification producing both Type II and Type I water, combined with ultraviolet sanitising and total organic carbon monitoring. Type II water is stored in a separate tank and is drawn from the tap on the tank. Type I water is drawn from a dispense controller mounted on the PurA-Q+ unit or an optional Remote Dispenser fitted with an Ultra Filter. The dispense controller releases a programmed volume of water.

All recorded data, warning messages and dispensing information are viewed from a display on the dispense controller. All components of the system are installed in a metal chassis and protected by a plastic housing that allows for the system to be placed on a bench or wall-mounted. The front panel is removable for access to the consumables.

The system is designed in accordance with the most recent technology and the latest safety regulations. It is recommended that the system is installed and commissioned by the manufacturer or their designated representative.



Water Quality Flow Rates

Product Water Quality	Product Water Flow Rate
Type I	2 liters/minute [0.53 gal/min]
Type II	15 to 25 liters/hour [5.3 to 6.6 gal/hour]

Purification Process

In normal operation, feed water enters the system through the **Inlet Solenoid Valve (V3)**, engaging the **Reverse Osmosis (RO) Pump (P1)**. The conductivity of the feed water is measured by the feed water conductivity sensor (**Q1**) before it reaches the pump.

The untreated water is pumped through the carbon-based, **Pre-Treatment Module (TC001)** to detain larger particles greater than 20 micron and chemicals such as insecticides, pesticides, herbicides and chlorides. The pre-treatment module is essential to protecting the RO membranes and must be replaced at the stated intervals to retain the integrity of the RO membranes as effectively and efficiently as possible.

From the pre-treatment module, water passes over the **RO Module** membrane (**TC026**). The membranes reject almost all bacteria, viruses, heavy metal compounds and organics, as well as 98 percent of the salt content from the water. A percentage of the rejected water, referred to as the concentrate, is sent to drain through a **Flow Restrictor (R1)** while the remaining water passes through the membranes again, conserving water usage.

The product water, referred to as permeate, is measured through the **Permeate Conductivity Sensor (Q2)** as it leaves the membrane. Should the water quality measure within the set limits, the **Permeate Solenoid Valve (V5)** is opened and the permeate water reaches the next level of purification. Should the water quality measure outside of the set-limits, the system will display a warning for the user to act accordingly and the permeate is recycled or flushed to drain as part of the **Auto-Flushing** feature.

The accepted water is pushed through the **Endure Purification Pack 1 (TC002)** which contains ion-exchange resins. The deionization process occurs and the permeate water quality is measured by the **Post-treatment (DI) Conductivity Sensor (Q3)**. The permeate water is fed into a *required* storage tank (**TANK**) where it is held as **Type II** water. The storage tank may be equipped with an **Ultraviolet (UV) Light (TC008)** to maintain bacteria sterilization in the stored water. Type II water can be dispensed from the tank through the dispenser tap on the storage tank when required.

Type I water is made through a polishing process that begins with the activation of the circulation pump by either the Integral Dispense Handset or the Remote Dispense Handset to draw Type II water from the storage tank. The water flow from the tank is monitored by a flow sensor (**SENS00018**). The polishing process takes the Type II water back into the PurA-Q+ unit, over the UV light (**TC003**), where the conductivity and Total Organic Carbon (TOC) is measured by the **Q4** sensor. The water then passes through the **Endure Purification Pack 2 (TC009)** which is filled with a high grade of mixed bed ion-exchange resins which enables the optimum resistivity of 18.2 MΩ-cm to be reached. The resistivity is verified as it leaves the **Type I Conductivity sensor (Q5)** and the temperature is then verified by the temperature sensor (**T1**).

If the temperature is outside the set-limits, then the flushing solenoid valve diverts the water to drain. A warning is displayed on the dispense control display. Flushing will continue until the temperature returns to its normal-operation setting.

When the user activates the dispenser, the dispense solenoid valve (**V8**) opens and desired water volume is dispensed. Attached to the dispenser is either a Bacteria filter (**TC011**) or an Endotoxin filter (**TC004**) to provide water with reduced levels of endotoxins and viruses.

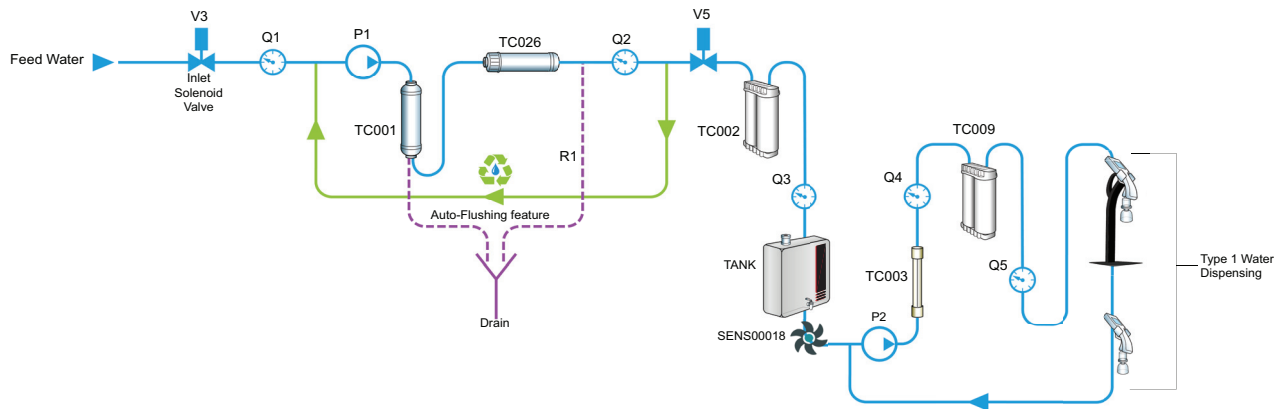



Figure 1. PurA-Q+ water purification process.

Table 1. Purification Process component descriptions

Component	Description	Component	Description
V3	Inlet Solenoid Valve	TANK	Storage Tank (30 litre, 60 litre, or 100 litre)
Q1	Feed Water Conductivity Sensor	TC008	Optional Ultraviolet Lamp (inside the storage tank)
P1	RO Pump	SENS00018	Flow Sensor
TC001	Pre-Treatment Module	P2	Recirculation (Booster) Pump
TC026	RO Module (membrane)	TC003	Ultraviolet Lamp (inside the PurA-Q+ unit)
R1	Flow Restrictor	Q4	Conductivity and Total Organic Carbon Sensor
Q2	Permeate Water Conductivity Sensor	TC009	Endure Purification Pack 2
V5	Permeate Water Solenoid Valve	Q5	Type I Water Conductivity Sensor
TC002	Endure Purification Pack 1	V8	Dispense Solenoid Valve (not shown)
Q3	Post-Treatment Water Conductivity Sensor	T1	Temperature Sensor (not shown)
	Integral Dispenser Handset		Remote Dispense Handset

Feed Water Requirements

The feed water used must meet these requirements.

Pressure: 0.1 to 6 bar [1.5 to 87 psi]

Temperature: 5 to 35 degrees C [45 to 90 degrees F]

Minimum Feed Water Flow: 1.0 Lpm at 0.1 bar [0.27 gpm at 1.5 psi]

Maximum Conductivity: less than 1400 μS

Free Chlorine: less than 0.1 mg per liter

pH: 3 to 9

Maximum Carbon Dioxide (CO₂): 15 mg per liter

Total Dissolved Solids: 800 ppm

Maximum Silica: 15 mg per Liter

Silt Density Index (SDI): less than 3

Hardness: less than 6 grains per 3.78 Litres [1 gallon] and less than 500 ppm CaCO₃

Langelier Index (LI): less than zero

Turbidity: less than 1 NTU

Iron: less than 0.1 mg per liter

Manganese: less than 0.05 mg per liter

Aluminum: less than 0.05 ppm

Organics: less than 1 ppm

Product Water Specifications

Product (Type I) Water Flow: 2 Litres/min

Product (Type II) Water Flow: 15 to 25 Litres/hour

Conductivity at 25° C: 0.055 $\mu\text{S}/\text{cm}$

Resistivity at 25° C: 18.2 M Ω/cm

Total Organic Carbon (TOC): 1 to 5 ppb

DNase, RNase, DNA: Free

Rejection Rate for Bacteria: greater than 90 percent

Rejection Rate for Particles: greater than 90 percent

Dispense Controller Primary Operation Menus and Sub-menus



Access Main menu.



View Active Alarms



MASTER
Dispenser
Menu

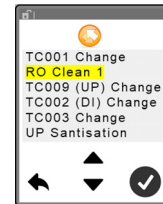
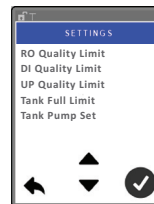
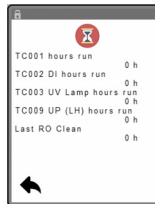

Turn off the unit.
(green)

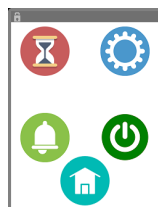

Second
Dispenser
Menu

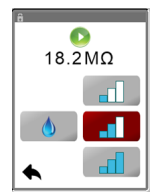

Access factory settings.
Password required



Change the current language



Sleep mode.

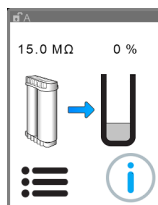

External storage tank is filling.



Access current readings



Access Main Menu

Operation

The Dispenser function also applies to the master and second dispenser.

Information Screen

When power is applied to the unit, an information screen appears displaying this information:

- Disp software version (Display)
- Base software version (Controller)
- Manufacturer contact information

User Settings

NOTE: User password **1111** is required to access the user settings.

This is the **User Settings** screen.

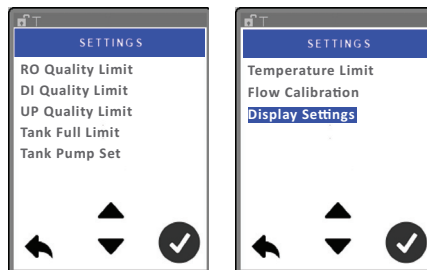

RO Quality Limit. Set the required water quality of the Type 3 water

DI Quality Limit. Post-treatment water conductivity setting

UP Quality Limit. Ultra-pure water conductivity setting

Tank Full Limit. Set the Full water level for the external storage tank (if applicable)

Tank Pump Set. Set the 100-litre storage tank pump pressure set point (if applicable)

Temperature Limit. Ultra-pure water temperature setting

Flow Calibration. Calibrate the volume of water dispensed

Display Settings. Set the number of minutes of inactivity before the display screen goes dark. Set the level of darkness of the display.

System Settings

Accessible only by qualified technician with a password.

Consumable Timers

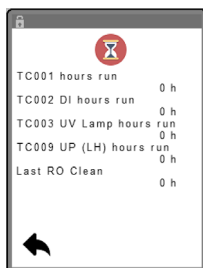



Displays the number of hours since these components were installed:

- Pretreatment Module TC001
 - UV lamp TC003
 - Endure Purification Pack 1 TC002
 - Endure Purification Pack 2 TC009
- and when the
- Last RO Clean operation was performed

Alarms (Warnings)

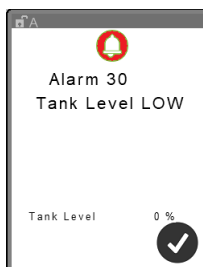







Displays active alarms. Alarms will automatically display as they occur. Touch the alarm name to display details.



Touch  to acknowledge the alarm. The alarm will stay in the list until the associated issue has been fixed.

Change Language

Follow this procedure.



1. On  or  or  touch , then on , touch 
2. On , touch the desired language and touch .

Configure User Settings



Follow this procedure.

1. Take one of these actions:



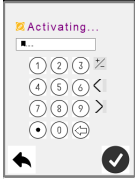

- On  or  or  touch 

- On , touch , then touch 

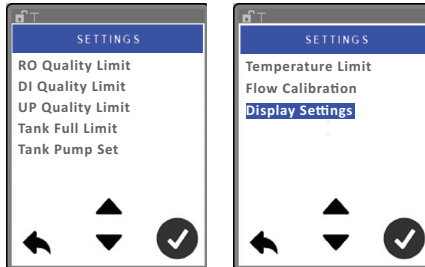
2. On , touch 

3. On , enter the User password **1111** and touch 



4. Touch the applicable setting and touch .
5. Touch  or  until the desired value is displayed.
6. Touch .
7. Repeat steps 4 through 6 until all applicable user settings are configured.
8. Touch  to return to the Dispense home screen.

Dispensing Deionized (DI) Water

The permeate water is fed into a storage tank (**TANK**) where it is held as deionized water. The water is dispensed from a tap or valve on the tank.

Dispensing Type I Water

Type I (Ultra Pure) water is drawn from the external storage tank using the dispense controller or the Remote Dispenser. The Dispense menu screen is displayed during normal operation.



The factory settings can be modified by the user as necessary. Below are the tasks required to configure the Dispense Controller.

NOTE: For Type I water, the storage tank may be equipped with an **Ultraviolet (UV) Light (TC008)** to maintain bacteria sterilization in the stored water. Section *Purification Process* on page 1 explains of how Type II water is converted to Type I water.

Setting the Dispense Speed

When the desired speed is selected, dispensing begins for a maximum of 850 seconds. Pressing any other button will stop the dispense operation. Press  to stop the dispense operation and return to the previous screen.

Follow this procedure.

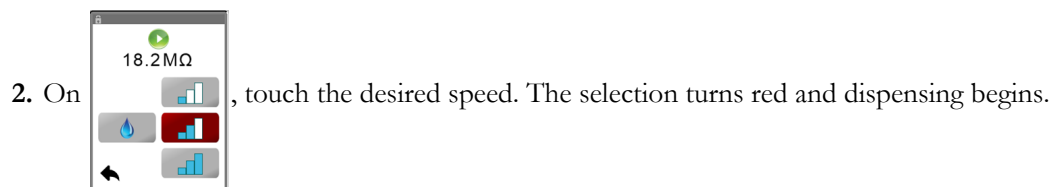

Drop by drop



Low Flow



Medium Flow





High Flow

Setting the Dispense Volume and Dispensing Water

Set the required volume of water to release before activating the dispense controller.

Follow this procedure.



2. Touch  or  until the desired number of litres is displayed.

NOTE: Dispense volume can be set up to 25 litres.

3. Touch  to start dispensing water.

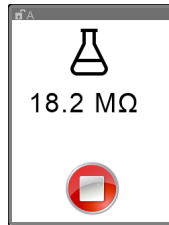

NOTE: The water flow will automatically stop when the programmed volume are dispensed.

- Touch  to stop the water flow sooner.



Calibrating the Dispense Volume

If the volume of water dispensed does not match the programmed volume, calibration is required.

IMPORTANT: You will need a container that measures in litres and is large enough to hold the required volume of water.

Follow this procedure.

1. Place a graduated cylinder below the dispense controller.



2. On , touch :





3. Touch . The programmed volume of water is dispensed.

4. Touch 

5. Touch 

6. On  or , touch .

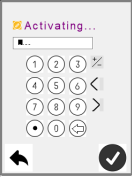



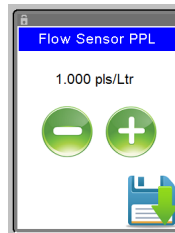

7. On , touch .

8. On , enter the User password **1111** and touch .

9. On , touch **Flow Calibration** and touch .



10. Observe the volume of water in the graduated cylinder and take one of these actions.

If the volume in the cylinder is...	Then,...	And then,...
The required volume	Touch 	---
Less than required,		Touch  to increase the volume of water dispensed. Touch  . Repeat steps 1 through 8 until the required volume is dispensed into the graduated cylinder.
More than required,	Touch  and empty the container.	Touch  to decrease the volume of water dispensed. Touch  . Repeat steps 1 through 8 until the required volume is dispensed into the graduated cylinder.

Warning Messages

Below is a list of warning messages and solutions.

Description	Error Number	Solution
Water leak (system shuts down)	60	Fix the leak. Dry the leak sensor located on the bottom of the cabinet. Contact Technical Support as necessary.
Permeate ^a	40	Contact Technical Support.
DI Quality Low ^b	41	Follow instructions on the screen.
Loop Resistivity ^c	42	Follow instructions on the screen.
Loop Temperature	43	Follow instructions on the screen.
Tank Empty	50	Follow instructions on the screen.
Tank Low	51	Follow instructions on the screen.
DI Quality Sensor Fault: LOW	62	Follow instructions on the screen.
Loop Conductivity Sensor Fault	63	Follow instructions on the screen.
Temperature Sensor: HIGH	64	Allow system to flush.
Temperature Sensor: LOW	65	Check incoming water temperature.
Level Sensor Fault: HIGH	67	Contact Technical Support.
Level Sensor Fault: LOW	68	Contact Technical Support.
Internal UV Lamp Run Time Expired	4	Contact Technical Support
Tank UV Lamp Run Time Expired	5	Contact Technical Support
Pretreatment Module TC001 time expired	1	Replace.
Endure Purification Pack 1 TC002 time expired	2	Replace.
Endure Purification Pack 2 TC009 time expired	3	Replace.
Inlet Conductivity: HIGH	24	Check conductivity in Feed Water. Contact Technical Support if necessary.
Pressure Sensor Fault: HIGH	69	100-litre storage tank with pump pressure sensor Contact Technical Support
Pressure Sensor Fault: LOW	70	100-litre storage tank with pump pressure sensor. Contact Technical Support
Pressure: HIGH	71	PurA-Q+ pressure sensor. Follow instructions on the screen. Contact Technical Support if necessary.

- a. When RO pump is ON
- b. When Permeate is ON
- c. When circulation pump is active

Routine Maintenance

Below is a schedule of routine maintenance intervals required to keep the System operating.

Table 2. Schedule of Routine Maintenance

Maintenance Required	Frequency	See Section...
Replace Pre-treatment Module	6 months, or when external storage tank is sanitised.	<i>Replace Pre-Treatment Module</i>
Replace Endure Purification Pack 1 (TC002)	6 months	<i>Replace Endure Purification Pack TC002</i>
Replace Endure Purification Pack 2 (TC009)	6 months and when the External Storage Tank or System is sanitised.	<i>Sanitize the External Storage Tank (as required) or Sanitise the System</i>
Replace Dispenser Endotoxin Filter or Bacteria Filter	6 months	<i>Replace Endotoxin Filter or Bacteria Filter</i>
RO Clean	Annually	<i>RO Clean</i>
Sanitize the External Storage Tank	As directed by customer, if bacterial contaminants dictate	<i>Sanitize the External Storage Tank (as required)</i>
Sanitise the system	Annually	<i>Sanitise the System</i>

Replace Pre-Treatment Module



The pre-treatment module should be replaced every 3 to 6 months depending on the quality of the supply water. The module is located behind the front panel of the RO machine. You will need **Pre-Treatment Module TC001**.

IMPORTANT: If the UV lamp inside the PurA-Q+ is being replaced, install the UV lamp before replacing the Pre-Treatment Module.

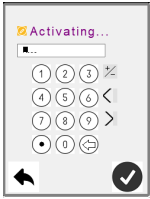

Follow this procedure.

1. Lift the left front panel and remove.
2. Remove the packaging from the Pretreatment Module TC001.





5. On  , enter Administrator password **3182** and touch 

6. On  , touch **TC001 Change** and touch 

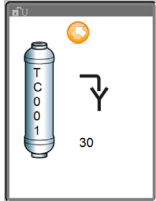
7. On  , touch 

When  appears, the pre-treatment module depressurizes for 30 seconds.

8. On  , touch 

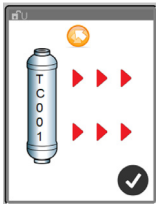
9. On  , remove the TC001 cartridge from the unit.

10. Touch 

11. On , install a new TC001 cartridge. Secure the module to the two brackets.

12. Touch .

13. When  appears, the cartridge will flush for 300 seconds (5 minutes).

14. On , touch .

15. Replace the left front panel.

16. Touch .

17. Dispose of the used module following local environmental disposal guideline.

Replace Endure Purification Pack TC002



Replace the **TC002 (DI) Endure Purification Pack 1** every 6 months.

NOTE: Replace the **TC009 (UP) Endure Purification Pack 2** every 6 months and when the external storage tank or the system is sanitised.

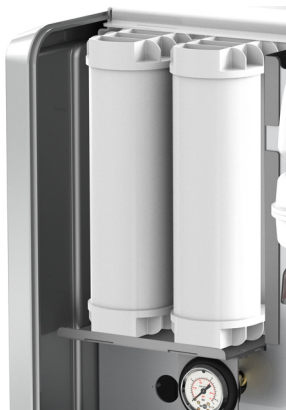

Follow this procedure to replace **Endure Purification Pack TC002**.



1. If you have not already done so, remove the left front panel.
2. Remove the packaging from the applicable **Endure Purification Pack**.

3. On  touch 

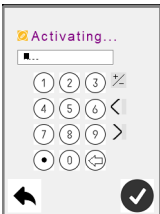
4. On  touch 

5. On  , enter User password **1111** and touch 

6. Select **TC002 (DI) Change** and touch 

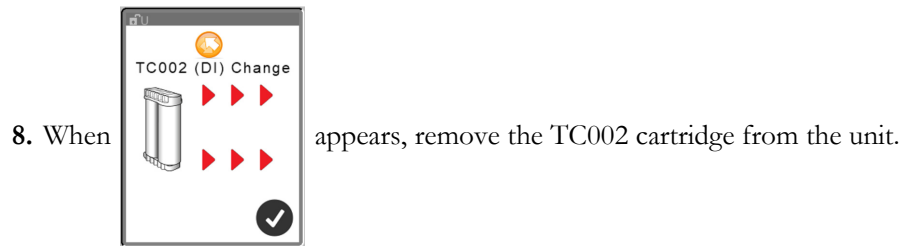
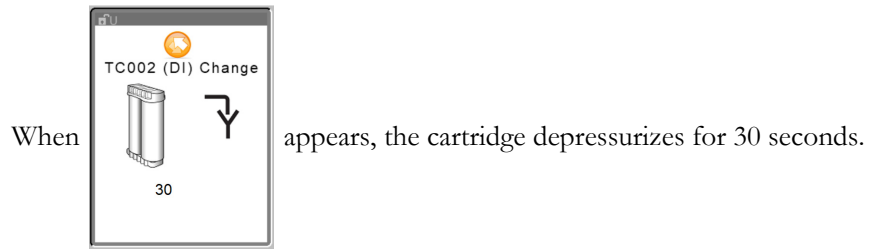
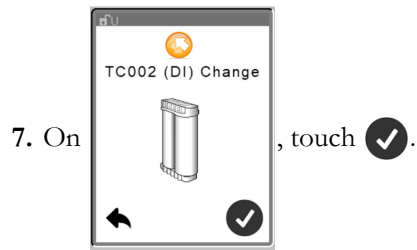

9. Remove the covers from the receptacles on the back of the new pack.



10. Place the new TC002 cartridge into the location.

11. Lift up on the back of the pack to slide the receptacles over the tubes on the back wall.

12. Be sure the pack is resting against the inside lip of the bracket and not on top of it as shown below.

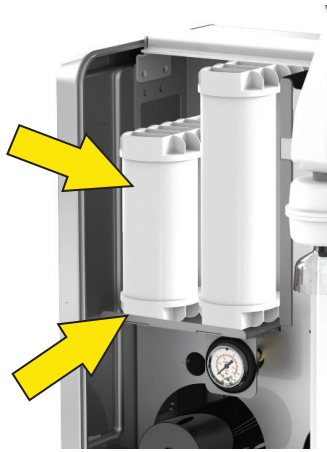

13. Touch

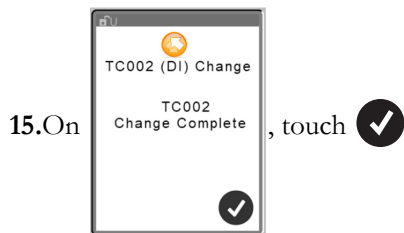
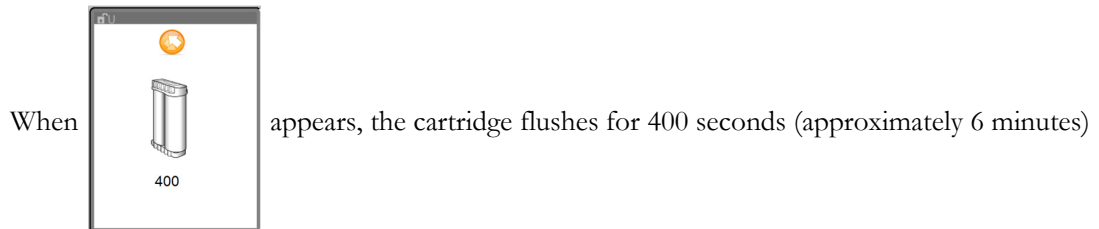
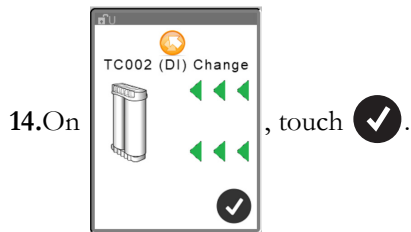

16. Touch

17. Replace the left front panel.

18. Dispose of the used purification packs following your site requirements for disposal.

Sanitise the System

The Avidity Science recommends sanitising the system every 6 months. You will need a new **Sanitisation cartridge TC010**.







WARNING! Severe personal injury. The sanitisation cartridge contains chlorine. Chlorine causes severe eye and skin irritation or burns. Avoid contact with eyes, skin, and clothing. Wear protective glasses and gloves during the sanitisation process. Wash hands thoroughly at the completion of the process.

1. Remove the left-front panel.

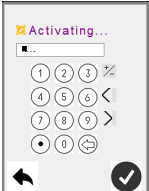
2. On  touch 

3. On  touch 

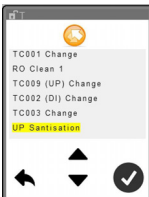
4. On  , enter the User password **1111** and touch 

5. On  , select **UP Sanitisation** and touch 

6. On  , touch 

7. When  appears the system depressurizes.

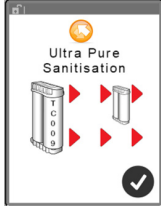
8. When  appears, remove **Endure Purification Pack 2 TC009**

9. Remove the packaging from the **Sanitisation Cartridge TC010**

10. Wearing protective gloves, remove the covers from the receptacles on the **Sanitisation Cartridge**





11. Touch 

12. When  appears, insert Sanitisation Cartridge TC010 in the position of TC009

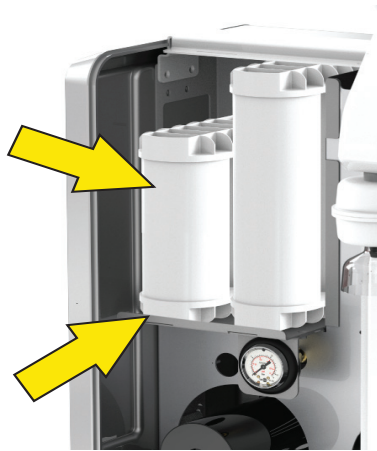
13. Be sure the pack is resting against the inside lip of the bracket and not on top of it. Refer to the image below.



14. Touch 

15. When  appears, the sanitising process begins

and counts down from 2819 seconds (approximately 46 minutes).

16. When  appears, remove TC010 cartridge.

17. Remove the packaging from the new **Endure Purification Pack 2 TC009** cartridge

18. Remove the covers from the receptacles on the back of the pack.





19. Touch 

20. When  appears, insert the new TC009 cartridge.

21. Lift up on the back of the pack to slide the receptacles over the tubes on the back wall.

22. Be sure the pack is resting against the inside lip of the bracket and not on top of it, as shown below.

23. Touch .

24. When  appears, the system will flush for 60 seconds

25. When  appears, touch 

26. Take off the protective gloves; they are no longer required.

27. Touch  until  appears.

28. Replace the left front panel.

29. If the site maintenance schedule indicates that it is close to the time to replace the **Endure Purification Pack 1 TC002**, go to procedure *Replace Endure Purification Pack TC002* on page 18. If not, go directly to step 30.

NOTE: Refer to the routine maintenance schedule in Table 2 on page 15.

30. Replace the left front panel.

31. Replace the Dispense Controller ultra filter or standard filter. Refer to section *Replace Endotoxin Filter or Bacteria Filter* on page 37.

Sanitize the External Storage Tank (as required)

The external storage tank must be sanitised when tests confirm high levels of bacterial contamination are found in the stored water.



WARNING! Personal injury. Do not swallow or crush chlorine sanitising tablets. Tablet may be harmful if swallowed. Crushing the tablet can create a dust that is irritating to the nose, eyes, and skin. Wear protective eye wear and gloves when handling tablets. Contact poison control center if swallowed. Wash thoroughly with soap and water after handling, before eating, drinking, chewing gum, using tobacco, or using toilet.

Follow this procedure.

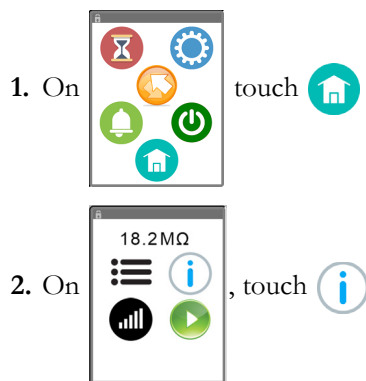

3. At **Tank Level**, be sure the value shown is greater than **60%**.

NOTE: If the Tank Level is less than 60 percent, reset the **Tank Level Limit** so it is greater than 60 percent to prevent excessive chlorine concentration during the sanitising process. Refer to *Configure User Settings* on page 9.

4. Touch

5. Disconnect power to the PurA-Q+ unit.

6. Insert the required quantity of **CT3** tablet, or equivalent, into the applicable storage tank. See table below.

NOTE: The number of tablets provides 25 ppm chlorine concentration for the applicable tank size.

Table 3. Quantity of sanitising tablets required for 25 ppm chlorine concentration.

Tank Size	Quantity of CT3 Sanitisation Tablets (or equivalent)	Chlorine Concentration
30-litre	1	25 ppm
60-litre	2	
100-litre (with or without pump)	3	

7. Let the chlorine solution set for 60 minutes.

- 8. Drain reservoir at the plug or dispense tap at the bottom of the tank until the tank is empty.
- 9. If a plug was removed, re-insert it now.
- 10. Apply power to the PurA-Q+ unit and allow the tank to fill to the Tank Full Limit (greater than 60 percent).

11. While the tank is filling, on  touch 



12. On  , touch 



- 13. be sure the **Tank Level** value is greater than **60%**.
- 14. Disconnect power to the PurA-Q+ unit and drain the tank again.
- 15. If a plug was removed, re-insert it now.
- 16. Apply power to the PurA-Q+ unit and allow the tank to fill to the Tank Full Limit (greater than 60 percent).
- 17. With the tank filled with water, use a chlorine test kit to check the residual chlorine concentration.
- 18. Take one of these actions.

If the residual Chlorine concentration is...	Then,...
Less than 0.05 ppm,	Go to step 19
Greater than 0.05 ppm	Repeat steps 14 through 18.

19. On  touch 

20. On  touch 

21. On , enter User password **1111** and touch 

22. On , select **UP Sanitisation** and touch 

23. Remove the left-front panel.

24. On , touch 

25. When  appears the system depressurizes.

26. When  appears, remove **Endure Purification Pack 2 TC009**

27. Remove the packaging from the **Sanitisation Cartridge TC010**

28. Wearing protective gloves, remove the covers from the receptacles on the **Sanitisation Cartridge**



29. Touch 

30. When  appears, connect Sanitisation Cartridge TC010 in the position of TC009.

31. Be sure the pack is resting against the inside lip of the bracket and not on top of it. Refer to the image below.

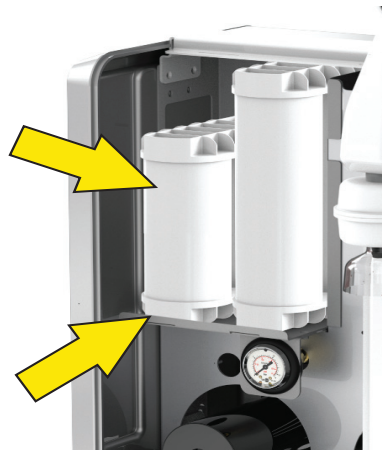

32. Touch 

33. When  appears, the sanitising process begins

and counts down from 2819 seconds (approximately 46 minutes).

34. When  appears, remove **TC010** cartridge.

35. Remove the packaging from the new **Endure Purification Pack 2 TC009** cartridge

36. Remove the covers from the receptacles on the back of the pack.





37. Touch .

38. When  appears, insert the new **TC009** cartridge.

39. Be sure the pack is resting against the inside lip of the bracket and not on top of it. as shown below.

40. Touch .

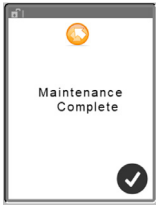
41. When  appears, the system will flush for 60 seconds

42. When  appears, touch 

43. Take off the protective gloves; they are no longer required.

44. Touch  until  appears.



45. Dispose of the sanitisation cartridge and the Endure Purification Pack 2 following local environmental disposal guidelines.

RO Clean

The RO Clean command initiates a process to sanitise the RO membrane(s). An RO Clean should be performed every 12 months or as bacterial growth dictates.

View Number of Hours Since Last RO Clean

Follow this procedure.

1. On  or , select 

2. On , **Last RO Clean** shows the total number of hours

Required Equipment

You will need this equipment for this process:

- Protective gloves and eye wear
- CT-1 Chlorine Tablets TC086
- Strainer Assembly AV034
- Pre-Treatment Module TC001

Perform RO Clean

Take one of these actions.

1. Take one of these actions.

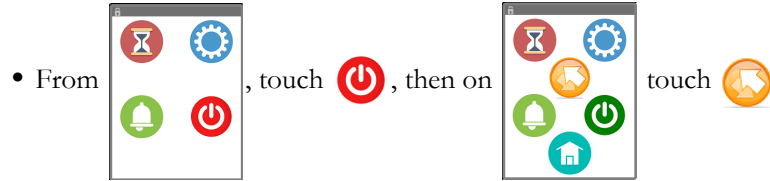

or

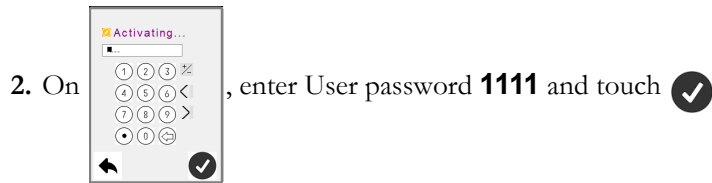

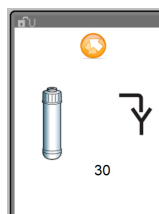

The flush valve opens and the system depressurizes for 30 seconds as shown below.

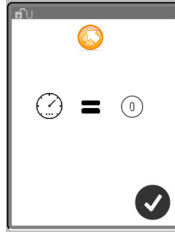

- When the pressure screen shown below appears, observe the pressure gauge to verify the system has depressurized.

NOTE: The system does not measure the pressure, so it is essential that the user verify that there is zero pressure before continuing.



- When the system is depressurized, touch . The flush valve closes.

- When  appears, lift the left front panel and remove the Pretreatment module **TC001**



from its brackets and disconnect the elbow fitting at each end.

- Place the cartridge in a safe location. It will be reconnected after the cleaning process.

- On , touch .

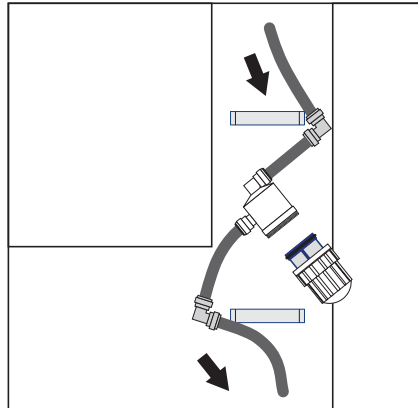
10. When  appears, connect Strainer **AV034** as shown below.



11. On , touch 

- The RO flush operation starts and a 300 second (5 minute) countdown begins.

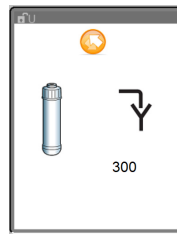

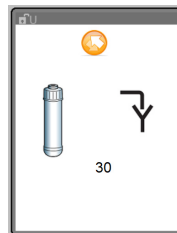

- The flush valve opens and the system depressurizes for 30 seconds as shown below

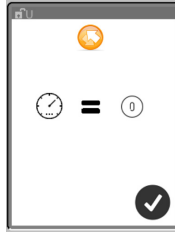

12. When the pressure screen shown below appears, observe the pressure gauge to verify the system has depressurized.

NOTE: The system does not measure the pressure, so it is essential that the user verify that there is zero pressure before continuing.



13. When the system has been confirmed to be depressurized, touch . The flush valve closes.

14. When  appears, unscrew the cap from the strainer housing.



WARNING! Severe personal injury. Chlorine tablets are harmful if swallowed. Avoid contact with eyes, skin, and clothing. Wear protective gloves and eye wear when handling the chlorine tablet. Keep chlorine tablets in tightly closed container and away from heat, combustible materials, and hot surfaces. Wash hands thoroughly after handling.





Precautionary Statements: Contact with skin or eyes may cause severe irritation or burns. Ingestion may cause severe burning to mouth, throat, and stomach and may be fatal.

First Aid Procedures: If a chlorine tablet is swallowed, do not induce vomiting. If conscious, give two glasses of water or milk. In case of contact with skin or eyes, immediately flush with plenty of water for at least 15 minutes. In all cases, contact a physician. Consult Safety Data Sheet for further health and safety information.

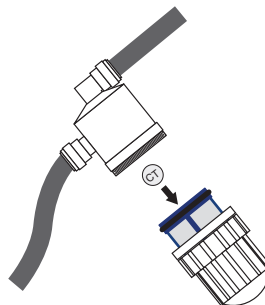
15. Wearing protective gloves and eye wear, insert one CT chlorine tablet into the strainer and secure the cap to the housing.



16. On , touch .

- The RO Clean and flush operation starts and a 900 second (15 minute) countdown begins.

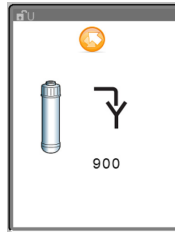

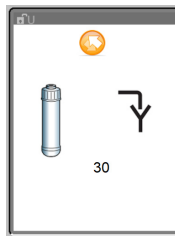

- The flush valve opens and the system depressurizes for 30 seconds as shown below

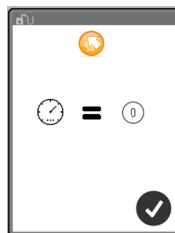

17. When the pressure screen shown below appears, observe the pressure gauge to verify the system has depressurized.

NOTE: The system does not measure the pressure, so it is essential that the user verify that there is zero pressure before continuing.



18. When the system has been confirmed to be depressurized, touch . The flush valve closes.

19. When  appears, disconnect the strainer from the pretreatment module connections.

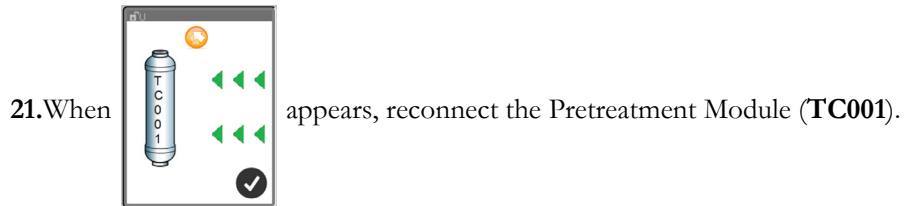
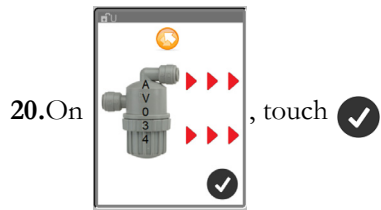

22. When the Pretreatment Module is reconnected, touch 

- The Pretreatment Module is flushed for 300 seconds (5 minutes)

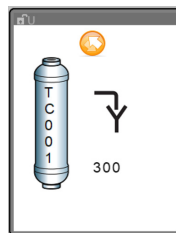

- At the conclusion of the flush, the RO clean process is complete.

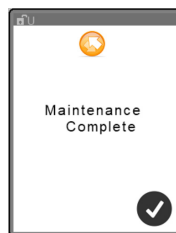

23. Touch  to return to the main menu.

Replace Endotoxin Filter or Bacteria Filter

Required equipment:

- Adapter ADAP00012 with o-ring for TC004 Endotoxin Filter
- Adapter ADAP00011 with o-ring for TC011 Bacteria Filter



Follow this procedure.

1. Remove the current filter from the base of the dispenser.
2. Remove the filter from its packaging.
3. Connect the applicable adapter as indicated below:
 - For Adapter ADAP00012, place the o-ring over the threads on the TC004 Endotoxin Filter.
 - For Adapter ADAP00011, insert the o-ring inside the threaded end of the adapter
4. Screw the applicable adapter onto the filter.
5. Push the adapter into the connection at the base of the dispenser.
6. Remove the plastic cap from the clear plastic filter shroud.



Figure 2. Bacteria Filter TC011 (left) and Endotoxin Filter TC004.

Replace Air Filter on External Storage Tank

All tanks use air filter (TC005). The air filter connects to the top of the storage tank.

Follow this procedure.

1. Remove the new air filter from its packaging.
2. Pull the existing filter off the top of the tank.
3. Turn the new filter so the flange-end faces down toward the filter-connection tube as shown below.
4. Place the filter over the tube on the tank, and press down.

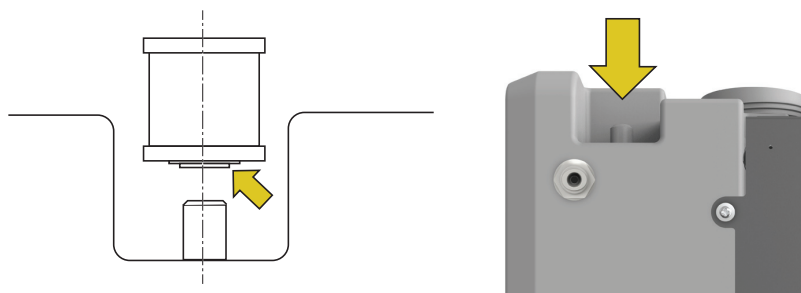

Consumables and Replacement Parts

These are the consumables and parts for replacement.

Consumables

Below is a list of items that require regular replacement.

Table 4. Consumable items.

Order Number	Description	Recommended Stock Quantity
TC050	Pre-Treatment Module (TC001)	---
TC051	Endure Purification Pack 1 (TC002)	---
TC057	Endure Purification Pack 2 (TC009)	---
TC058	Sanitisation Cartridge (TC010)	---
TC052	UV Lamp (TC003)	---
TC056	UV Lamp, External Storage Tank (TC008)	---
TC054	Air Filter, External Storage Tank (TC005)	---
TC053	Dispenser Endotoxin Filter (TC004)	---
TC059	Dispenser Bacteria Filter (TC011)	---
TC073	RO Membrane (TC026)	1
TC086	CT-1 Chlorine Tablets	1

Replacement Parts

Below are the replacement parts that are available. Parts will be replaced by an Authorized Technician as necessary or as part of a Preventive Maintenance program.

Table 5. Replacement parts.

Order Number	Description	Recommended Stock Quantity
HOUS00006	UV Housing	1
THIM00001	UV Thimble	1
UVBA00001	UV Ballast	1
SENS00003	Total Organic Carbon Conductivity Sensor	1
	Ultra Pure Permeate Conductivity Sensor	1
	Post-Treatment Conductivity Sensor	1
Part of LOOM00007	Temperature Sensor	1
DISP00023	Dispenser Handset for Integral installation	1
DISP00024	Dispenser Handset for Remote installation	1

Table 5. Replacement parts. (Continued)

Order Number	Description	Recommended Stock Quantity
AV053	Remote Dispense Gun complete	1
STRA00001	Strainer (for AV034 assembly)	1
VALV00062	Dispense Solenoid Valve	1
VALV00004	Ring main Solenoid Valve	1
	Inlet Solenoid Valve	1
	Flushing Solenoid Valve	1
	RO Permeate Solenoid Valve	1
VALV00011	Pressure Control Valve	1
CONT00001	Main Control Board	1
BATT00001	Main Control Board Battery	1
CONT00002	Dispenser Control Board	1
SENS00007	Leak Detector	1
ADAP00002	Power Supply Unit	1
VALV00003	Pressure Reducing Valve	1
VALV00002	Inlet Check Valve	1
	Pulsation Dampener Check Valve	1
SENS00005	Inlet Conductivity Sensor	1
	RO Permeate Conductivity Sensor	1
PUMP00001	RO Pump	1
DAMP00001	Pulsation Dampener	1
	RO Housing	1
VALV00002	Pulsation Dampener Check	1
GAUG00001	Pressure Gauge	1
REST00002	Concentrate Flow Restrictor Recirculation Loop Flow Restrictor (Green)	1
VALV00005	Pressure Control Valve	1
VALV00008	Check Valve, 10 psi	1
VALV00010	Check Valve	1
SENS00018	Flow Sensor	1
PUMP00016	Circulation Pump	1
DISP00006	Display Touchscreen	1
TUBE00002	Tube 1/4-inch, white (1-metre section)	2
TUBE00001	Tube 5/16-inch, white (1-metre section)	2
TUBE00003	Tube 3/8-inch, white (1-metre section)	2

Table 5. Replacement parts. (Continued)

Order Number	Description	Recommended Stock Quantity
LEAD00001	Power Cord (UK)	1
LEAD00002	Power Cord (EU)	1
LEAD00004	Power Cord (US)	1
LEAD00005	Power Cord (China)	1
WIRE00027	UV Lamp to UV Ballast Wiring Harness	1
WIRE00007	UV Fault Wiring Harness	1
WIRE00014	Power-In Wiring Harness	1
LOOM00007	Wiring Loom for Sensors	1
LOOM00008	Wiring Loom for Solenoids	1

External Storage Tank Replacement Parts

Below are the available external storage tanks for replacement.

Table 6. Storage Tank Replacement Parts.

European Part Number	Description	Recommended Stock Quantity
TANK30	Tank, 30 litre	---
TANK60	Tank, 60 litre	---
TANK100	Tank, 100 litre	---
TANK100P-01	Tank, 100 litre with integral pump, 230V	---
TANK100P-02	Tank, 100 litre with integral pump, 115V	---
CONT00003	Controller (power inverter) for 230V pump	---
CONT00005	Controller (power inverter) for 115V pump	---
PUMP00005	Pump, 100-litre tank	---
LEAD00002	Power cord for 100-litre Tank with pump (EU)	---
LEAD00001	Power Cord for 100-litre Tank with pump (UK)	---
LEAD00004	Power Cord for 100-litre Tank with pump (US)	---
LEAD00005	Power Cord for 100-litre Tank with pump (China)	---
SENS00016	Water Level Sensor	1

Table 6. Storage Tank Replacement Parts. (Continued)

European Part Number	Description	Recommended Stock Quantity
SENS00009	Pressure Sensor (0 to 10 bar), 100-litre Tank with pump	1
FUSE00002	Fuse, 100-litre Tank with 230V pump	1
FUSE00003	Fuse, 100-litre Tank with 115V pump	1
LOOM00013	Water Level Sensor Wiring Harness	---
LOOM00014	Pressure Sensor Wiring Harness for TANK 100-litre with pump	---
LOOM00019	Internal Wiring Harness for 100-litre Tank with pump	---
AV012	UV Lamp Assembly (includes transformer and UV lamp) NOTE: See <i>Consumables</i> on page 39 for UV lamp part number.	---
LABL00043	Label for 100-litre Tank	---